

Type: P9640

Inverse Definite Minimum Time (IDMT) Earth Fault Relay

- ❑ True R.M.S. measurements
- ❑ Adjustable Low-set and High-set tripping threshold (with option to disable High-set tripping)
- ❑ Adjustable Time Multiplier for defining curve tripping characteristic (applicable to Low-set triggering only)
- ❑ Normal Inverse 3/10 tripping characteristics (Low-set threshold only)
- ❑ Instantaneous tripping on High-set triggering
- ❑ Test and Reset button for simulating and clearing of fault condition
- ❑ Red LED indication of Low-set or High-set triggering and tripping
- ❑ Green LED indication for Auxiliary power supply presence
- ❑ Microprocessor based (self checking) with non-volatile memory
- ❑ Terminals suitable for 2 x 2.5mm² wires (complete with protective cover)



Dims:
 W x H. 96 x 96mm (front)
 W x H. 89.5 x 89.5mm (main body)
 L. 107mm

PRESENTATION

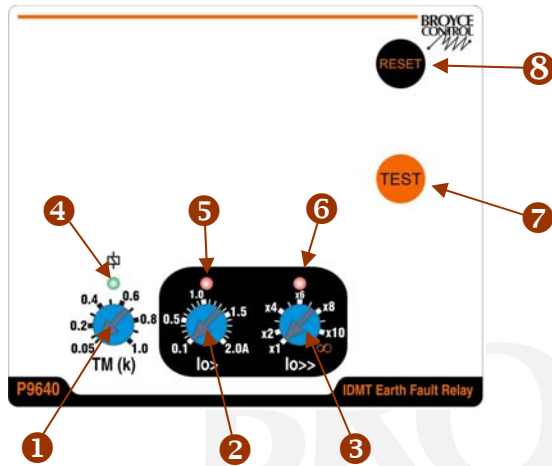

1. "Time Multiplier" adjustment*
 2. "Low-set I₀>" trip adjustment*
 3. "High-set I₀>>" trip adjustment*
 4. "Power supply" green LED indication
 5. "Low-set triggered" red LED indication
 6. "High-set triggered" red LED indication
 7. "TEST" button
 8. "RESET" button
- * accessible only when the front cover is open

GENERAL OVERVIEW

The P9640 (from the P9600 series family of IDMT/DT relays) is a microprocessor based relay designed to monitor and detect Earth faults in 3-phase applications. Typically the P9640 is wired in conjunction with external current transformers of the feeder to be protected.

The adjustments and indicators are laid out to help the user during set-up and fault finding. The adjustment for the **Low-set** for example has its corresponding red LED positioned above it so it is clear to which function this LED relates to. The same also applies to the **High-set** adjustment and LED. Adjustment and LED operation is explained further on the next page.

The adjustment for **TM (k)** (which defines the curve response to tripping) is assigned to the **Low-set** triggering only. The **High-set** does not have any additional adjustments and hence will trip instantaneously if triggered. If required, the **High-set** can be set to disabled.

A Test mode is provided (also accessible with the tamperproof transparent cover closed) to confirm the correct operation of the internal relay. The relay will energise when the "TEST" button is pressed and de-energise when the "RESET" button is pressed.

OPERATION

Example 1.

When an Overcurrent occurs in one of the phases and the level of current exceeds the "**Low-set I₀>**" trip threshold, the corresponding red LED above the adjustment illuminates. The time out then commences however the point at which tripping occurs is defined by:

- A, the level of current that is above the trip threshold.
- B, the Time Multiplier setting.

When tripping finally occurs, the red LED will then flash indicating a tripped condition.

If the fault current has been removed, pressing the "**RESET**" button will return the relay back to normal operation. The red LED will then extinguish.

Example 2.

If a fault current occurs such that it exceeds the "**High-set I₀>>**" trip threshold the relay will de-energise with no delay. The red LED above the "**High-set I₀>>**" adjustment will flash.

In the event of an Earth fault condition, the basic sequence of events is shown below.

☞ Assuming High-set trip is enabled.

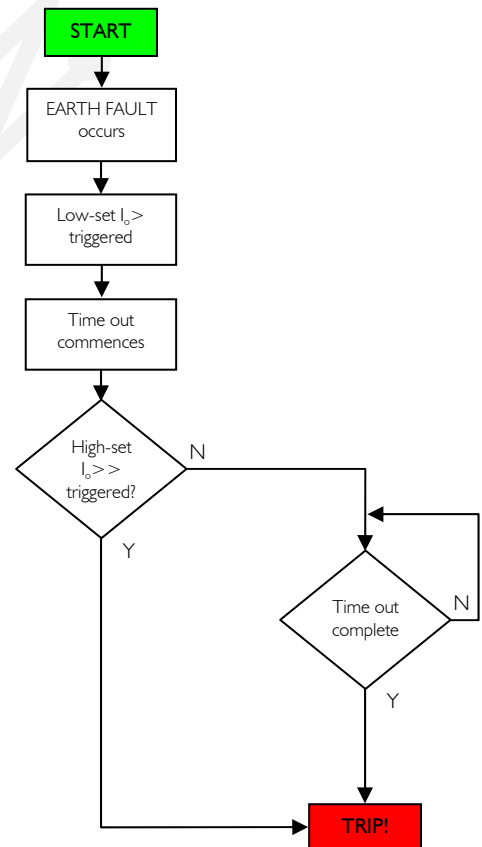

• INSTALLATION



Installation work must be carried out by qualified personnel.

- **BEFORE INSTALLATION, ISOLATE THE SUPPLY. THIS PRODUCT IS DESIGNED TO CONNECT TO SEVERAL TYPES OF CIRCUITS. ENSURE ALL ARE ISOLATED**
- Remove the P9640 from the packaging.
- Lift the raised part of the side clip in order to remove from the housing. Carry this out on each side.
- Insert the P9640 into the panel cut-out and fit the side clips back on to the housing.
- Slide the clips towards the front of the unit until they come in to contact with the reverse of the panel. The unit is now secured in place.
- Connect wires to the rear terminals as required.
- The P9640 is now ready for powering and setting.

☞ *The front window of the P9640 is supplied with a clear protective film which can be removed as and when necessary.*

• NORMAL OPERATION

- Apply power to the unit and the green "Power supply" LED will illuminate.



• TEST MODE

- Press and hold the **TEST** button and the relay will energise. Both the red "lo>" and "lo>>" LED's will illuminate.
- Release the **TEST** button and the relay will remain energised.
- Press the **RESET** button to de-energise the relay. Both red LED's will extinguish.

☞ *Testing should be carried out on a regular basis to check the integrity of the P9640.*



DO NOT use this product to provide a means of isolating circuits in order to work on when placed in the "TEST" mode. This should only be done by means of operating isolators, circuit breakers or other methods of removing power in this application.

• SETTING & OPERATION

Setting of the P9640 is carried out using the 3 potentiometers located behind the transparent cover.

1. Time Multiplier (TM (k))



The adjustment for "TM (k)" (Time Multiplier) defines the tripping characteristic when the "Low-set" threshold "lo>" has been exceeded. The lower the setting, the faster the response to tripping. The higher the setting, the slower the response.

2. Low-Set Trip threshold (lo>)



The adjustment for the "Low-set" can be set from 0.1 to 2A. When the threshold is exceeded due to an Earth fault condition, the corresponding red LED above the adjustment illuminates indicating activity. When tripping finally occurs, the red LED will then flash.

3. High-Set Trip threshold (lo>>)

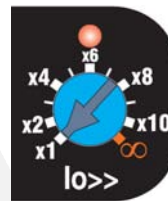

The adjustment for the "High-set" can be set from x1 to x10 then disable i.e.



The scale markings are multipliers of what has been set on the "Low-set" threshold. For example if the "Low-set" is set to 1.5A and "High-set" x6, this will be the equivalent of $1.5 \times 6 = 9A$.

When the threshold is exceeded due to an Earth fault condition, the corresponding red LED above the adjustment illuminates indicating activity. When tripping finally occurs, the red LED will then flash.

☞ *If tripping occurs whereby the High-set level is exceeded, only the LED for the High-set will illuminate/flash. This allows the user to clearly identify which threshold was triggered causing the trip.*

☞ *There is no delay associated with High-set therefore, tripping is instantaneous.*

• LED FUNCTION SUMMARY

☞ *The green LED will remain illuminated for as long as power is applied to the Aux. connections (Terminals 1 and 2).*

In response to an Earth fault condition:

Status	lo>	lo>>
Normal	LED off	LED off
Low-set triggered	LED on	LED off
Low-set Tripped	LED flashing	LED off
High-set triggered	LED off	LED on
High-set Tripped	LED off	LED flashing

In response to Test and Reset button operation:

Button press	lo>	lo>>
TEST	LED on	LED on
RESET	LED off	LED off

Key:

- LED off
- LED on
- LED flashing

• TECHNICAL SPECIFICATION

Supply voltage U_n (1, 2):	115VAC \pm 15% 230VAC \pm 15% <i>(Voltage should be specified at time of ordering)</i>
Rated frequency:	50/60Hz
Isolation:	Over voltage cat. III
Rated impulse withstand voltage:	4kV (1.2 / 50 μ S) IEC 60664
Power consumption:	3W max.

Rated current input I_n :	5A (directly connected)
Rated frequency:	50Hz
Burden:	<0.4VA @ I_n
Overload:	4 x I_n (continuous)

External CT's (15, 16): Class P recommended. (with 5A secondary)

Earth fault settings:	
Low-set trip ($I_{o>}$):	0.10 – 2.0A (2 – 40%)
Time multiplier (TM):	0.05 – 1.0
High-set trip ($I_{o>>}$):	x1 – x10 or disable (∞)
High-set definite time:	Instantaneous (<50ms)

Pick up value:	+2% of trip setting
Accuracy:	
Protection thresholds:	\pm 5%
Response time:	\pm 5% (with a minimum of 50ms)
Repeat accuracy:	\pm 0.5% @ constant conditions

Ambient temperature:	-10 to +60°C
Relative humidity:	+95% (non-condensing)

Output:	
(RL1 - 3, 4, 5):	1 x SPDT relay
Output rating:	AC1 250V 8A (2000VA) AC15 250V 5A (1250VA) DC1 25V 8A (200W)
Electrical life:	\geq 150,000 ops at rated load
Dielectric voltage:	2kV AC (rms) IEC 60947-1
Rated impulse withstand voltage:	4kV (1.2 / 50 μ S) IEC 60664

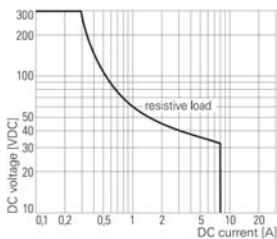

Max. DC Load Breaking Capacity

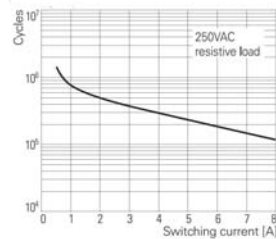

Electrical Endurance

Housing:	Flame retardant Lexan
Protection:	IP55 / IP20 (rear)
Weight:	\approx 450g
Mounting:	Panel mounting. Cut-out = 91 x 91 mm (\pm 0.5mm)
Max. panel thickness:	12mm
Terminal conductor size:	0.05 - 2.5mm ² (30 - 12AWG)
Recommended tightening torque:	10in lb (1Nm)
Wire stripping length:	0.24 – 0.30in (6 – 7.5mm)
Approvals:	Conforms to IEC, CE and and RoHS Compliant. EMC: Immunity: EN/IEC 61000-6-2 Emissions: EN/IEC 61000-6-4 Generic: IEC 60255-26 (EMC), IEC 255-3, IEC 60255-151

() Bold digits in brackets refer to terminal numbers on the rear of the unit.

Options:

The P9600 range also includes individual Overcurrent or Earth fault relays available with either IDT or IDMT tripping characteristics. Please refer to separate data sheets.

Tripping Curve Characteristics (Normal Inverse 3/10).

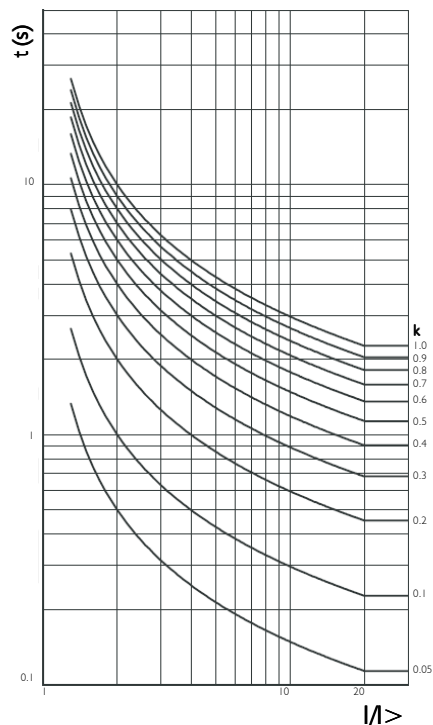

• CONNECTION DIAGRAM

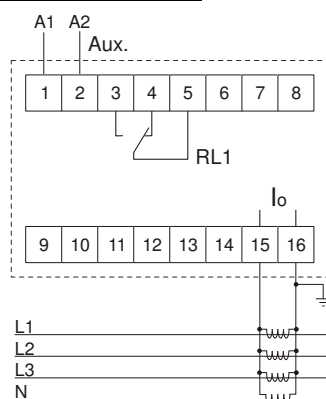

• DIMENSIONS

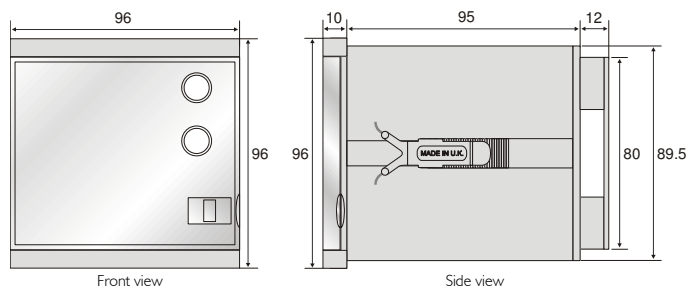

All dimensions are in mm.