

Type: P9660

Earth Fault Relay

- ❑ True R.M.S. measurements
- ❑ Low Set and High Set tripping thresholds
- ❑ 6 selectable IDMT (Inverse Definite Minimum Time) characteristic curves
- ❑ Adjustable DT (Definitive Time)
- ❑ Measurement and live display of earth fault current
- ❑ Pre-defined selectable CT ratio's (5:5.....5000:5)
- ❑ Microprocessor based (self checking) with non-volatile memory
- ❑ "Ecosmart" Energy efficient power supply design
- ❑ Rear mounted pluggable connectors for supply, relay contacts and current input

Dims:
W x H. 96 x 96mm (front)
W x H. 89.5 x 89.5mm (main body)
L. 100mm



PRESENTATION

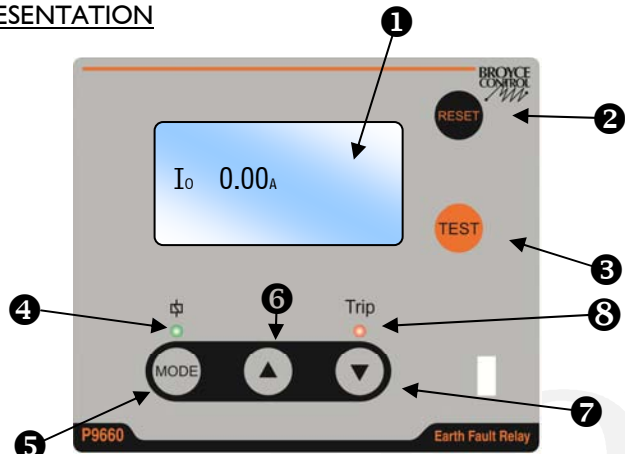

- | | |
|--|-------------------------------------|
| 1. LCD (Liquid Crystal Display) for user information | 5. "MODE" button* |
| 2. "RESET" button | 6. Parameter increment button* |
| 3. "TEST" button | 7. Parameter decrement button* |
| 4. "Power supply" green LED indication | 8. "Trip status" red LED indication |
- * accessible only when the front cover is open

OPERATION & OVERVIEW

The P9660 (from the P9600 series family of IDMT/DT relays) is a microprocessor based relay designed to monitor and detect an Earth fault current by measurement of the imbalance of the current from a current transformer arrangement like that shown in the Connection Diagram on Page 5.

A clear backlit LCD provides all the key information that the user requires for both operation and the setting up. Setting is achieved in a few simple steps and requires no previous knowledge of product operation.

Normal operation provides the user with the actual live earth fault current on one screen. The actual current represents that of the current passing through the primary side of the externally connected CT. This is achieved by the setting of the ratio for the CT.

Programming mode allows the user to assign the operation of both internal relays for either Auto or Manual resetting. Relay 2 has the added option of being allowed to energise at the start or end of a time out period. If assigned to energise at the start, the Relay can be used to operate a buzzer or lamp giving early warning before a system actually shuts down.

Low-set and High-set thresholds can be programmed for the Earth fault detection. The time current characteristic of the low-set units are selectable between Normal Inverse curve 3/10, Normal Inverse curve 1.3/10, Long Time Inverse curve, Very Inverse curve, Extremely Inverse curve, Extremely Inverse 0.65 curve and Definitive Time. High-set units are the Definitive Time type. Instantaneous tripping is possible by setting the time to minimum.

A simple Summary screen is displayed once the programming is complete. The same screen can also be displayed by subsequent presses of the "RESET" button. This allows the user to access key information with the tamperproof transparent cover closed and sealed.

A Test mode is provided (also accessible with the tamperproof transparent cover closed) to confirm the correct operation of the internal relays. The relays will energise when the "TEST" button is pressed and de-energise when the button is released (AUTO Reset) or when the "RESET" button is pressed (MAN reset).

FUNCTION OVERVIEW

Programming mode.

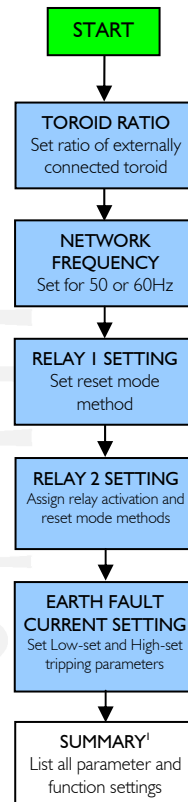

Programmable parameters

User settings summary mode

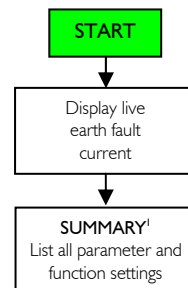

¹ Displaying of the Summary screen during normal operation is achieved via subsequent presses of the "RESET" button. See Section 7. QUICK VIEW OF USER SETTINGS for further information.

• INSTALLATION



Installation work must be carried out by qualified personnel.

• BEFORE INSTALLATION, ISOLATE THE SUPPLY. THIS PRODUCT IS DESIGNED TO CONNECT TO SEVERAL TYPES OF CIRCUITS. ENSURE ALL ARE ISOLATED ^

- Remove the P9660 from the packaging.
- Lift the raised part of the side clip in order to withdraw from the housing. Carry this out on each side.
- Insert the P9660 into the panel cut-out and fit the side clips back on to the housing.
- Slide the clips towards the front of the unit until they come in to contact with the reverse of the panel. The unit is now secured in place.
- Wire the supplied female pluggable connectors as required.
- Plug the connectors into the relevant sockets on the rear of the unit.
- The P9660 is now ready for powering and programming.

☞ The front window of the P9660 is supplied with a clear protective film which can be removed as and when necessary.

^ When carrying out future maintenance on the product or application and it becomes necessary to disconnect the connectors from the product, ensure for the Current Transformer connector, **they do not remain open circuit**. This can lead to high voltages being present on this connector.

• NORMAL OPERATION

- Apply power to the unit and the green "Power supply" LED will illuminate.
- The LCD will momentarily display a welcome screen as shown...

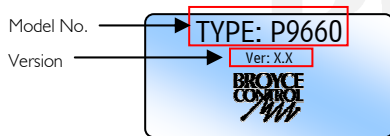

...then after a short delay reverts to indicating the following information:

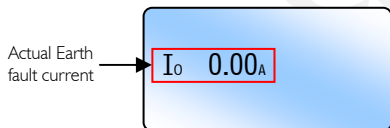

• TEST MODE

- Press and hold the **TEST** button and both relays will energise. The LCD will display the characters "TEST" and the product part number (as below). The LCD backlight and red "Trip" LED will flash.

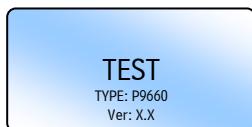

- Release the **TEST** button and the relay(s) will remain energised if set to Manual reset or de-energise if set to Auto reset.
- Press the **RESET** button to de-energise relay(s) which are set to Manual reset. The LCD will revert back to Normal operation. The LCD backlight and red "Trip" LED will stop flashing.

☞ Testing should be carried out on a regular basis to check the integrity of the P9660.



DO NOT use this product to provide a means of isolating circuits in order to work on when placed in the "TEST" mode. This should only be done by means of operating isolators, circuit breakers or other methods of removing power in this application.

• PROGRAMMING

Programming/setting of the P9660 is carried out using the 3 buttons located behind the transparent cover.



The **MODE** button selects the required parameter to be changed. The buttons either increment or decrement a value accordingly.

Any adjustments made are stored by the pressing and holding of the **RESET** button until the LCD shows the word "Saved!" See Section 6. SAVING OF SETTINGS.

☞ Please read the "Notes during programming" before commencing with the following.

IA. TOROID RATIO

☞ Setting the Toroid Ratio will allow the "actual" Earth fault current (I_0) to be displayed on the LCD which represents that of the current flowing through the parallel connected, external CT's. If no CT's are used, the parameter should be set to 5/5 (i.e. 1:1). Use this if the fault current is likely to be <5A.

☞ Default setting is "5/5"

- Press and hold the **MODE** button. The LCD displays a screen showing the characters "User Settings" then the following screen appears...

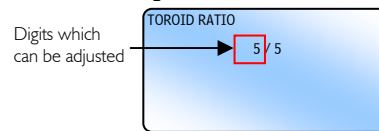

- Press either **up arrow** or **down arrow** to set the primary value of the external CT's.

☞ The digit after the forward slash "/" cannot be changed.

IB. NETWORK FREQUENCY

☞ Default setting is "50Hz"

- Whilst in the same screen as that for the Toroid Ratio (see IA.), press the **MODE** button to display the options for **NETWORK FREQUENCY**.

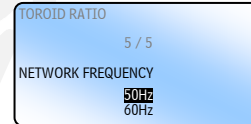

- Press either **up arrow** or **down arrow** to select between 50Hz or 60Hz. This should be set to suit the frequency of the network being monitored.

- Press and hold the **MODE** button to set the options for "Relay 1" as described in the next section.

2. RELAY 1 SETTING

☞ Default setting for Relay 1 is Manual resetting mode.

- The LCD displays the following screen.

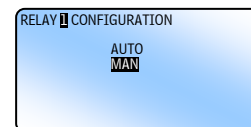

Actual LCD presentation when adjustable parameters are displayed.

- Press either **up arrow** or **down arrow** to select between **AUTO** resetting or **MANUAL** resetting (after a fault has occurred).

- Press and hold the **MODE** button to set the options for "Relay 2" as described in the next section.

continued on next page...

PROGRAMMING (continued)

3. RELAY 2 SETTING

☞ Default setting for Relay 2 is to energise at the end of the time out period.
Resetting mode is Auto.

- Setting of "Relay 2" is carried out in a similar manner as "Relay 1"; however it is necessary to assign the relay to either energise at the start (S) or end (E) of the time out period.

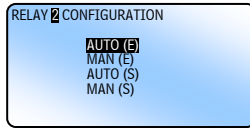

Actual LCD presentation when adjustable parameters are displayed.

- Press and hold the **MODE** button to set the options for "EARTH FAULT" as described in the next section.

4. EARTH FAULT SETTING

☞ Default settings for Earth Fault are shown in the LCD screen example in this section.

- Settings for Earth fault are displayed in turn following subsequent presses of the **MODE** button. The Low-set trip current (Io>) is displayed first.

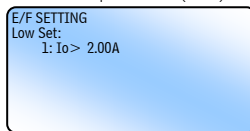

- Press either **▲** or **▼** to change the current.
- Press the **MODE** button to select the remaining settings and use the **▲** and **▼** buttons to change them.

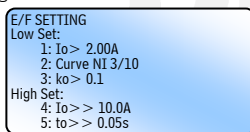

Actual LCD presentation when adjustable parameters are displayed.
Screen example above also shows the default settings for OVERCURRENT.

- Press and hold the **MODE** button to view the summary of settings for "EARTH FAULT" as described in the next section.

☞ If the Curve in selection "2:" is set to Definite Time, then selection "3:" will display "3: t>" and the required delay can then be set.

☞ If High-set is set to Disable in selection "4:", then Io>> or to>> cannot be adjusted.

5. EARTH FAULT SUMMARY

☞ It is not possible to edit settings when this screen is displayed.

- Following the setting of "Earth Fault", the LCD displays the "Earth Fault" screen showing a summary of the settings made during programming. All settings are displayed. The selected CT ratio, Network Frequency and Relay operation (following a Reset) information is also displayed.

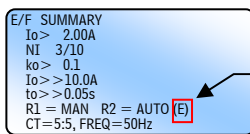

The letter in brackets refers to whether Relay 2 has been set to trigger at the start or end of the time out period.
(E) = End of time out
(S) = Start of time out
Either abbreviation can appear after the word MAN or AUTO
See Section 3. RELAY 2 SETTING

6. SAVING OF SETTINGS

- If after viewing the Summary screen the settings are correct, press and hold the **RESET** button until the word "Saved." appears. Any new settings are now stored.
- The screen will revert back to Normal operation.

7. QUICK VIEW OF USER SETTINGS

☞ It is not possible to edit settings when these screens are displayed.
☞ This feature can also be activated with the front window closed!

- Press and hold the **RESET** button to display the initial power up screen.

- Press the same button again to display the "Last Tripped Information" screen (refer to the next section for further information on this feature).
- Press again to display the "Earth Fault Summary" screen.
- Press again to display the contact details for Broyce Control.
- Press again to revert back to Normal operation.

8. LAST TRIPPED INFORMATION

☞ This information is held in memory even if power is removed. If a new trip event occurs, this information will be overwritten.

This feature allows the user to view the key information relating to the last trip condition. It is accessed as described in Section 7 on the left. It highlights the level of current at the time the trip occurred; the triggering method (Low-set or High-set) and which relays were activated. An example is shown below.

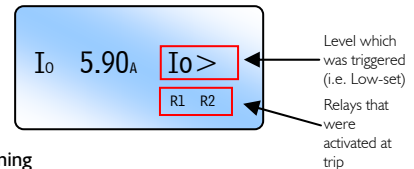

Notes during programming

☞ If during programming it is necessary to abort, press the **RESET** button briefly.

☞ Pressing and holding either **▲** or **▼** for > 1 sec. will increment or decrement the new value at a quicker rate.

☞ Stepping through each User Setting screen is performed by pressing and holding the **MODE** button until the desired screen is displayed.

Short presses of the **MODE** button will allow further editable settings to be changed within a specific screen.

☞ If the user remains in a setting or summary screen where no adjustments or button presses are made within a certain period, the screen will revert back to Normal operation. Additionally, any settings that have been made but not stored will not be saved.

☞ "E/F" refers to Earth fault.

TRIPPING MODE

- When an Earth fault condition occurs, the current displayed on the LCD increased accordingly. When the level of current exceeds the Low-set setting, the reading will be highlighted by the digits flashing.
- The LCD backlight will flash.
- Relay 2 will energise immediately if set to energise at the start of the time out period (See Section 3. RELAY 2 SETTING).
- The characters "Io>" will display to indicate the Low-set has been triggered.

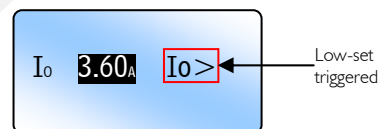

- If the current continues to increase above the High-set setting, the characters "Io>" will change and display "Io>>" to indicate the High-set has been triggered.

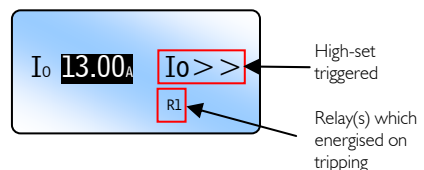

- When the unit finally trips, the digits will stop flashing and remain highlighted. This allows the user to see what current caused the unit to trip.
- The red "Tripped" LED will also flash.
- The relays which energised are also displayed on the screen after tripping.
- Press **RESET** to reset and return the unit back to normal operation (assuming the fault has been cleared). The LCD reverts back to displaying the normal system currents and the red "Tripped" LED stops flashing.

☞ If either relay is set for Auto resetting, then they would have de-energised after the fault had cleared. The corresponding relay ident (i.e. R1 and/or R2) on the display would also disappear. Pressing the "RESET" button will only clear the LCD. If either relay is set for Manual resetting, then pressing the "RESET" button will de-energise the relay(s) and clear the LCD.

• **IDMT CHARACTERISTIC CURVES**

Normal Inverse 3/10 (NI 3/10)*

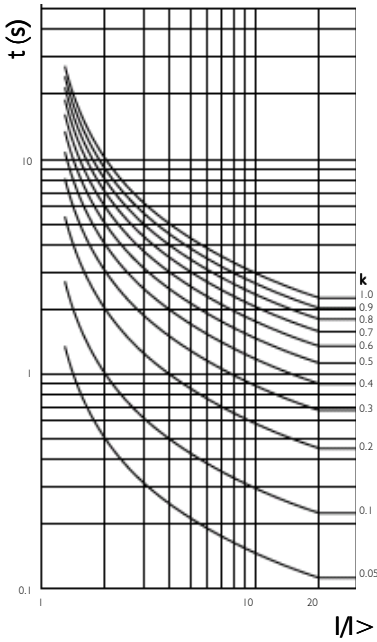

Normal Inverse 1.3/10 (NI 1.3/10)*

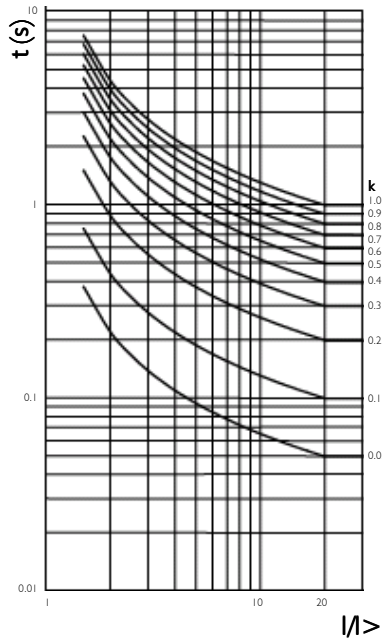

Long Time Inverse (LTI)*

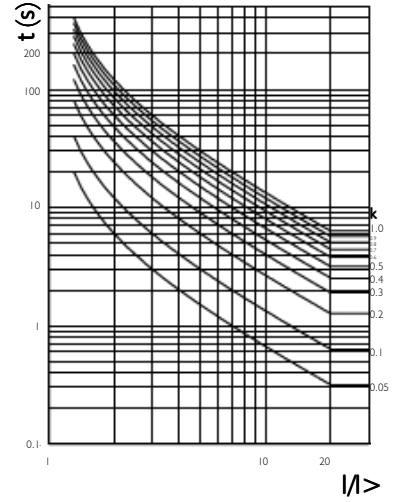

Very Inverse (VI)*

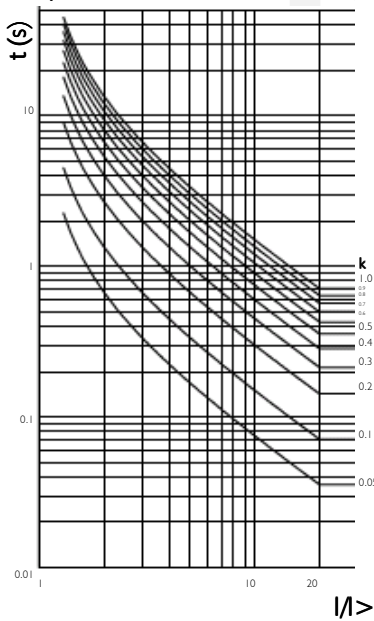

Extremely Inverse (EI)*

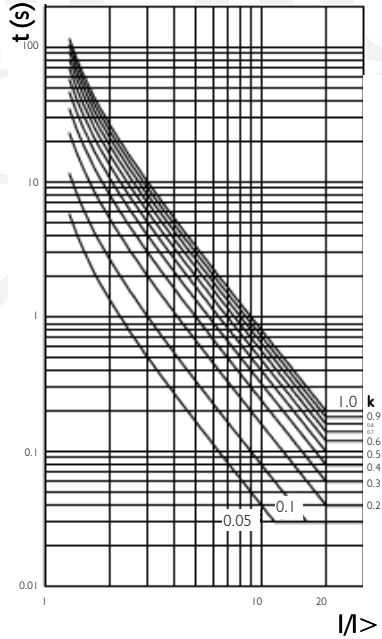

Extremely Inverse (EI 0.65)*

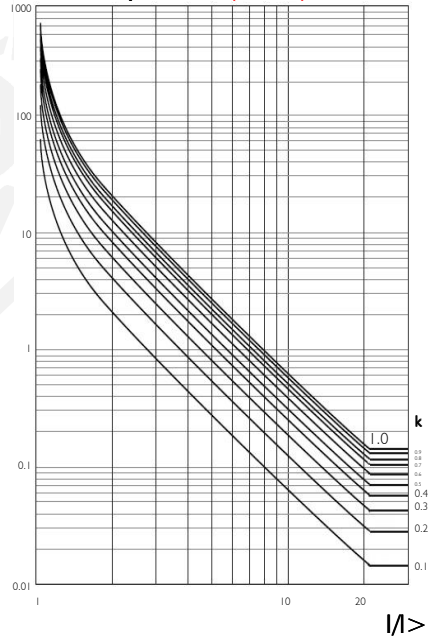

* Abbreviations used in the LCD screen for the selected IDMT characteristic curve.

The sequence of curves that are presented to the user when programming is shown below

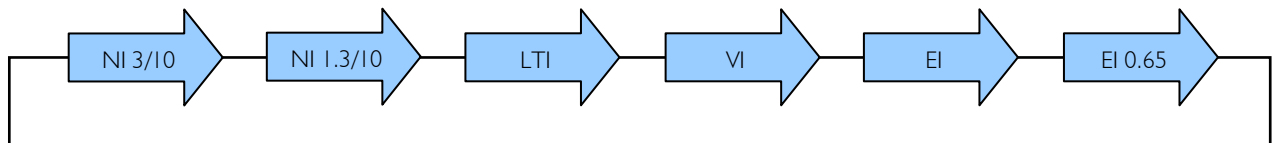

TECHNICAL SPECIFICATION



Supply voltage Un (1, 2): 85 – 265VAC/85 – 370VDC
18 – 57VAC/18 – 75VDC
(Voltage range should be specified at time of ordering)

Rated frequency: 50/60Hz (AC Supplies)

Isolation: Over voltage cat. III

Rated impulse withstand voltage: 4kV (1.2 / 50µs) IEC 60664

Power consumption: 3W max.

Rated current input In: 5A (directly connected)

Rated frequency: 50/60Hz

Burden: <0.4VA @ In

Overload: 4 x In (continuous)

External CT (15,16): Class P recommended. (with 5A secondary)

Maximum CT primary current rating: 5000A

Earth fault settings:

Low-set trip ($I_{o>}$): 0.10 – 5.00A (2 – 100%)

Low-set time multiplier ($k_{o>}$): 0.05 – 1.00

Low-set definite time ($t_{o>}$): 0.05 – 100s

High-set trip ($I_{o>>}$): 0.10 – 50.0A (2 – 1000%) or disable

High-set definite time ($t_{o>>}$): 0.05 – 2.5s

Pick up value: +2% of trip setting

Accuracy:

Protection threshold: ± 5%

Time delay (DT): ± 5% (with a minimum of 50mS)

Time delay (IDMT): ± 5% (with a minimum of 50mS and $I > 1.2 \times$ set-trip)

Actual Earth fault current: ± 1% of rated current In

Display update time: < 1 sec.

Repeat accuracy: ± 0.5% @ constant conditions

Ambient temperature: -10 to +60°C

Relative humidity: +95%

Output:

(RL1 - 3, 4, 5): 1 x SPDT relay

(RL2 - 6, 7, 8): 1 x SPDT relay

Output rating:
AC1 250V 8A (2000VA)
AC15 250V 5A (1250VA)
DC1 25V 8A (200W)

Electrical life: ≥ 150,000 ops at rated load

Dielectric voltage: 2kV AC (rms) IEC 60947-1

Rated impulse withstand voltage: 4kV (1.2 / 50µs) IEC 60664

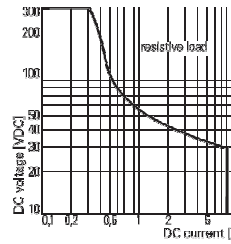

Max. DC Load Breaking Capacity

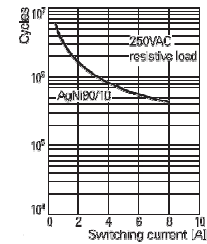

Electrical Endurance

Housing: Flame retardant Lexan

Protection: IP55 / IP20 (rear)

Weight: ≈ 410g

Mounting: Panel mounting. Cut-out = 91 x 91 mm (± 0.5mm)

Max. panel thickness: 12mm

Terminal type: UL94 V-0 rated pluggable and re-wireable female connectors comprising:
2-way (Power supply 1, 2)
6-way (Relay contacts 3...8)
8-way (CT input 15, 16)

Note that terminals 9 to 14 are not used on this model and should be left unconnected.

Terminal conductor size: 0.05 - 2.5mm² (30 - 12AWG)

Recommended tightening torque: 4.4in lb (0.5Nm)

Wire stripping length: 0.24 – 0.30in (6 – 7.5mm)

Approvals: Conforms to IEC, CE and and RoHS Compliant.
EMC: Immunity: EN/IEC 61000-6-2
Emissions: EN/IEC 61000-6-4
Generic: IEC 60255-26 (EMC), IEC 255-3, IEC 60255-151

() Bold digits in brackets refer to terminal numbers on the rear of the unit.

Options:

The P9600 range also includes combined Overcurrent or Earth fault relays available with either IDMT or DT characteristics. Additionally, a voltage, power and frequency monitoring only product is also available. Please refer to separate data sheets.

CONNECTION DIAGRAM

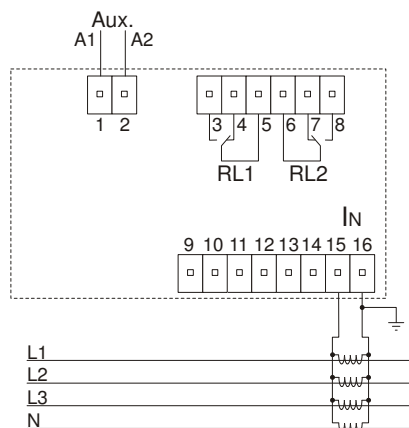

DIMENSIONS

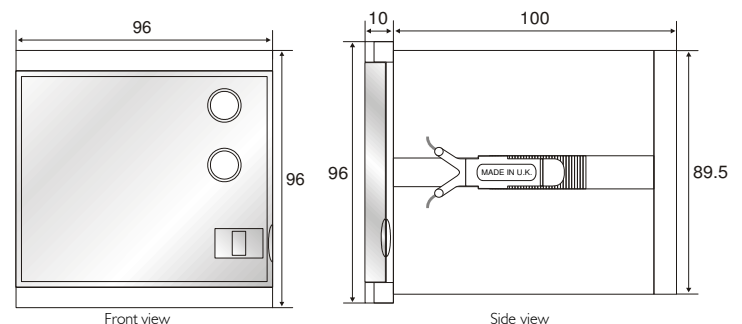

All dimensions are in mm.

