

Type: P9690

Combined Overcurrent / Earth Fault Relay and Voltage Monitoring

- ❑ True R.M.S. measurements
- ❑ Low Set and High Set tripping thresholds for both Overcurrent and Earth Fault detection
- ❑ 6 selectable IDMT (Inverse Definite Minimum Time) characteristic curves or adjustable DT (Definitive Time)
- ❑ Three phase over current and Earth fault detection
- ❑ Measurement and live display of individual phase and earth fault currents
- ❑ Pre-defined selectable CT ratio's (5:5....5000:5)
- ❑ Display of measured phase to neutral or phase to phase voltages
- ❑ Display of measured frequency, power, power factor and hours run
- ❑ Microprocessor based (self checking) with non-volatile memory
- ❑ "Ecosmart" Energy efficient power supply design
- ❑ Rear mounted pluggable connectors for supply, relay contacts and current inputs



Dims:
W x H. 96 x 96mm (front)
W x H. 89.5 x 89.5mm (main body)
L. 100mm

PRESENTATION

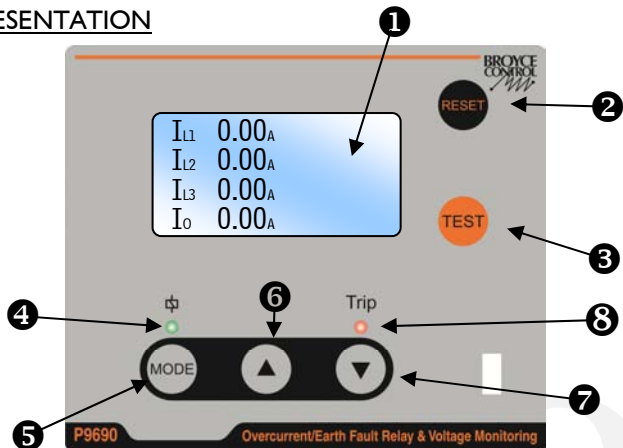

1. LCD (Liquid Crystal Display) for user information
 2. "RESET" button
 3. "TEST" button
 4. "Power supply" green LED indication
 5. "MODE" button*
 6. Parameter increment button*
 7. Parameter decrement button*
 8. "Trip status" red LED indication
- * accessible only when the front cover is open

OPERATION & OVERVIEW

The P9690 (from the P9600 series family of IDMT/DT relays) is a microprocessor based relay designed to monitor and detect Overcurrent on individual phases and non-directional Earth faults (by measurement of the neutral current) in 3-phase applications. Typically the P9690 is wired in conjunction with external current transformers of the feeder to be protected.

In addition, the P9690 is also able to measure and display, phase to neutral or phase to phase voltages along with the system frequency. It can also calculate the power factor and power for each phase. Finally, it will indicate total hours for as long as it remains powered. Note that tripping of this product only occurs on Overcurrent or Earth faults. It will not trip due to voltage or power issues.

A clear backlit LCD provides all the key information that the user requires for both operation and the setting up. Setting is achieved in a few simple steps and requires no previous knowledge of product operation.

Normal operation provides the user with actual live individual phase currents and earth fault current all on one screen. The actual phase current represents that of the current passing through the primary side of the externally connected CT's. This is achieved by the setting of the ratio for the CT.

Programming mode allows the user to assign the operation mode for both internal relays. They can be individually assigned to Overcurrent, Earth fault or a combination of both. They can also be configured for Auto or Manual resetting. Relay 2 has the added option of being allowed to energise at the start or end of a time out period. If assigned to energise at the start, the Relay can be used to operate a buzzer or lamp giving early warning before a system actually shuts down.

Low-set and High-set thresholds can be programmed for both Overcurrent and Earth fault detection. The time current characteristic of the low-set units are selectable between Normal Inverse curve 3/10, Normal Inverse curve 1.3/10, Long Time Inverse curve, Very Inverse curve, Extremely Inverse curve, Extremely Inverse 0.65 curve and Definitive Time. High-set units are the Definitive Time type. Instantaneous tripping is possible by setting the time to minimum.

Two simple Summary screens are displayed once the programming is complete. The same screens can also be displayed by presses of the "RESET" button. This allows the user to access key information with the tamperproof transparent cover closed and sealed.

A Test mode is provided (accessible with the tamperproof cover closed) to confirm the correct operation of the internal relays. The relays will energise when the "TEST" button is pressed and de-energise when the button is released (AUTO Reset) or when the "RESET" button is pressed (MAN Reset).

FUNCTION OVERVIEW

Programming mode.

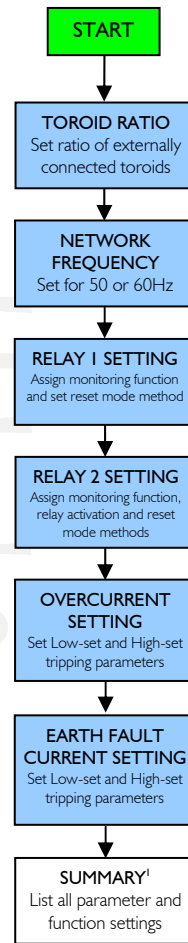

Programmable parameters

User settings summary mode

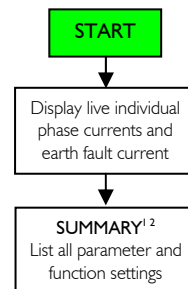

¹ Summary screens are split into two with one screen showing Overcurrent settings and the other showing Earth fault settings.

² Displaying of the Summary screens during normal operation is achieved via subsequent presses of the "RESET" button. See Section 8. QUICK VIEW OF USER SETTINGS for further information.

● **INSTALLATION**



Installation work must be carried out by qualified personnel.

● **BEFORE INSTALLATION, ISOLATE THE SUPPLY. THIS PRODUCT IS DESIGNED TO CONNECT TO SEVERAL TYPES OF CIRCUITS. ENSURE ALL ARE ISOLATED ^**

- Remove the P9690 from the packaging.
- Lift the raised part of the side clip in order to withdraw from the housing. Carry this out on each side.
- Insert the P9690 into the panel cut-out and fit the side clips back on to the housing.
- Slide the clips towards the front of the unit until they come in to contact with the reverse of the panel. The unit is now secured in place.
- Wire the supplied female pluggable connectors as required.
- Plug the connectors into the relevant sockets on the rear of the unit.
- The P9690 is now ready for powering and programming.

☞ The front window of the P9690 is supplied with a clear protective film which can be removed as and when necessary.

^ When carrying out future maintenance on the product or application and it becomes necessary to disconnect the connectors from the product, ensure for the Current Transformer connector, **they do not remain open circuit**. This can lead to high voltages being present on this connector.

● **NORMAL OPERATION**

- Apply power to the unit and the green "Power supply" LED will illuminate.
- The LCD will momentarily display a welcome screen as shown...

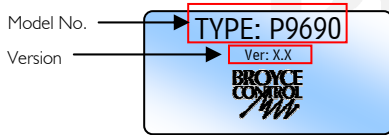

...then after a short delay reverts to indicating the following information:

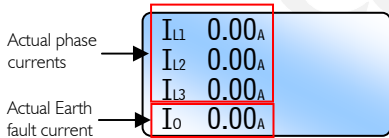

● **TEST MODE**

- Press and hold the **TEST** button and both relays will energise. The LCD will display the characters "TEST" and the product part number (as below). The LCD backlight and red "Trip" LED will flash.



- Release the **TEST** button and the relay(s) will remain energised if set to Manual reset or de-energise if set to Auto reset.
- Press the **RESET** button to de-energise relay(s) which are set to Manual reset. The LCD will revert back to Normal operation. The LCD backlight and red "Trip" LED will stop flashing.

☞ Testing should be carried out on a regular basis to check the integrity of the P9690.



DO NOT use this product to provide a means of isolating circuits in order to work on when placed in the "TEST" mode. This should only be done by means of operating isolators, circuit breakers or other methods of removing power in this application.

● **PROGRAMMING**

Programming/setting of the P9690 is carried out using the 3 buttons located behind the transparent cover.



The **MODE** button selects the required parameter to be changed. The buttons either increment or decrement a value accordingly.

Any adjustments made are stored by the pressing and holding of the **RESET** button until the LCD shows the word "Saved!" See Section 7. SAVING OF SETTINGS.

☞ Please read the "Notes during programming" before commencing with the following.

IA. TOROID RATIO

☞ Setting the Toroid Ratio will allow the "actual" Phase currents (IL1, IL2, IL3) and Neutral current (Io) displayed on the LCD to represent that of the currents flowing through the external CT's. If no CT's are used, the parameter should be set to 5/5 (i.e. 1:1). The setting applies to all CT's.

☞ Default setting is "5/5"

- Press and hold the **MODE** button. The LCD displays a screen showing the characters "User Settings" then the following screen appears...

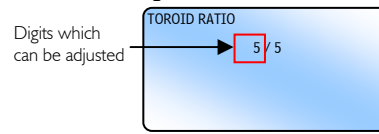

- Press either **up** or **down** to set the primary value of the external CT's.

☞ The digit after the forward slash "/" cannot be changed.

IB. NETWORK FREQUENCY

☞ Default setting is "50Hz"

- Whilst in the same screen as that for the Toroid Ratio (see IA.), press the **MODE** button to display the options for **NETWORK FREQUENCY**.

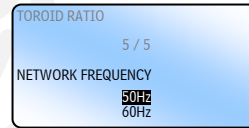

- Press either **up** or **down** to select between 50Hz or 60Hz. This should be set to suit the frequency of the network being monitored.

- Press and hold the **MODE** button to set the options for "Relay 1" as described in the next section.

2. RELAY 1 SETTING

☞ Default setting for Relay 1 is linked to "O/C & E/F". Resetting mode is Manual.

- The LCD displays the following screen. The options under "1:" are displayed and the default setting highlighted.

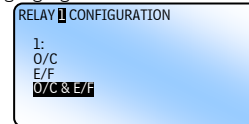

- Press either **up** or **down** to select how Relay 1 is assigned to tripping.

- Press the **MODE** button and the options under "2:" for resetting are displayed and the default setting highlighted.

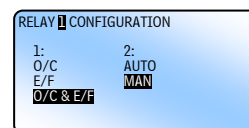

Actual LCD presentation when adjustable parameters are displayed.

- Press either **up** or **down** to select between **AUTO** resetting or **MANUAL** resetting (after a fault has occurred).

continued on next page...

PROGRAMMING (continued)

- Press and hold the **MODE** button to set the options for "Relay 2" as described in the next section.

3. RELAY 2 SETTING

☞ Default setting for Relay 2 is linked to "O/C & E/F" and energising at the end of the time out period. Resetting mode is Auto.

- Setting of "Relay 2" is carried out in a similar manner as "Relay 1", however it is necessary to assign the relay to either energise at the start (S) or end (E) of the time out period.

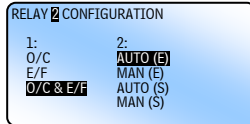

Actual LCD presentation when adjustable parameters are displayed.

- Press and hold the **MODE** button to set the options for "OVERCURRENT" as described in the next section.

4. OVERCURRENT SETTING

☞ The description for the Curves is abbreviated when displayed on the screen. Refer to "IDMT Characteristic Curves" for further explanation.

☞ Default settings for Overcurrent are shown in the last LCD screen example in this section.

- Settings for Overcurrent are displayed in turn following subsequent presses of the **MODE** button. The Low-set trip current (I>) is displayed first.

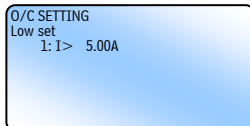

- Press either **▲** or **▼** to change the current.
- Press the **MODE** button to select the remaining settings and use the **▲** and **▼** buttons to change them.

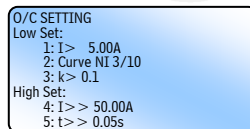

Actual LCD presentation when adjustable parameters are displayed. Screen example above also shows the default settings for OVERCURRENT.

- Press and hold the **MODE** button to set the options for "EARTH FAULT" as described in the next section.

☞ If the Curve in selection "2:" is set to Definite Time, then selection "3:" will display "3: t>" and the required delay can then be set.

☞ If High-set is set to Disable in selection "4:"; then I>> or t>> cannot be adjusted.

5. EARTH FAULT SETTING

☞ Default settings for Earth Fault are shown in the LCD screen example in this section.

- Settings for Earth Fault are carried out in the same manner as described for Overcurrent.

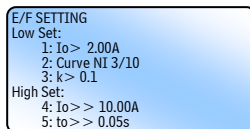

Screen example showing the default settings for EARTH FAULT.

- Press and hold the **MODE** button to see a summary of the "OVERCURRENT" then "EARTH FAULT" settings as described in the next section.

☞ If the Curve in selection "2:" is set to Definite Time, then selection "3:" will display "3: to>" and the required delay can then be set.

☞ If High-set is set to Disable in selection "4:"; then Io>> or to>> cannot be adjusted.

6. OVERCURRENT & EARTH FAULT SUMMARY

☞ It is not possible to edit settings when these screens are displayed.

- Following the setting of "Earth Fault", the LCD displays the "Overcurrent Summary" screen showing a summary of the settings made during programming. All settings are displayed. The selected CT ratio, Network Frequency and Relay operation (following a Reset) information is also displayed.

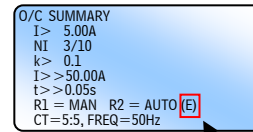

The letter in brackets refers to whether Relay 2 has been set to trigger at the start or end of the time out period.
(E) = End of time out
(S) = Start of time out
Either abbreviation can appear after the word MAN or AUTO
See Section 3. RELAY 2 SETTING

- Press and hold the **MODE** button to display the "Earth Fault Summary" screen.

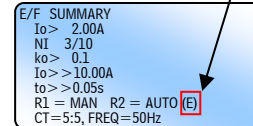

7. SAVING OF SETTINGS

- If after viewing the Summary screens the settings are correct, press and hold the **RESET** button until the word "Saved." appears. Any new settings are now stored.
- The screen will revert back to Normal operation.

8. QUICK VIEW OF USER SETTINGS

☞ It is not possible to edit settings when these screens are displayed.

☞ This feature can also be activated with the front window closed!

- Press and hold the **RESET** button to display the initial power up screen.
- Press the same button again to display the "Last Tripped Information" screen (refer to the next section for further information on this feature).
- Press again to display the "Overcurrent Summary" screen.
- Press again to display the "Earth Fault Summary" screen.
- Press again to display the contact details for Brocye Control.
- Press again to revert back to Normal operation.

9. LAST TRIPPED INFORMATION

☞ This information is held in memory even if power is removed. If a new trip event occurs, this information will be overwritten.

This feature allows the user to view the key information relating to the last trip condition. It is accessed as described in Section 8 above.

It highlights the cause of the trip (i.e. which phase for example), the level of current at the time the trip occurred; the triggering method (Low-set or High-set) and which relays were activated. An example is shown below.

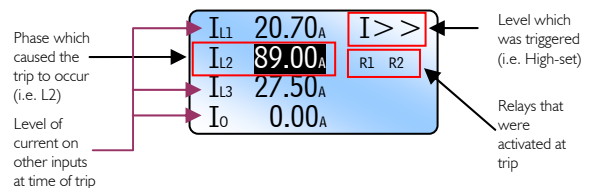

Notes during programming

☞ If during programming it is necessary to abort, press the **RESET** button briefly.

☞ Pressing and holding either **▲** or **▼** for > 1sec. will increment or decrement the new value at a quicker rate.

☞ Stepping through each User Setting screen is performed by pressing and holding the **MODE** button until the desired screen is displayed.

Short presses of the **MODE** button will allow further editable settings to be changed within a specific screen.

☞ If the user remains in a setting or summary screen where no adjustments or button presses are made within a certain period, the screen will revert back to Normal operation. Additionally, any settings that have been made but not stored will not be saved.

☞ "O/C" refers to Overcurrent and "E/F" refers to Earth fault.

• TRIPPING MODES

I. OVERCURRENT

- A fault which develops on a phase will be indicated by an increase in current reading on the LCD. When the level of current exceeds the Low-set setting, the phase at fault will be highlighted by the digits flashing.
- The LCD backlight will flash.
- Relay 2 will energise if assigned to Overcurrent and set to energise at the start of the time out period (See Section 3. RELAY 2 SETTING).
- The characters "I>" will display to indicate the Low-set has been triggered.

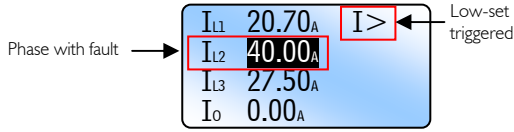

- If the current continues to increase above the High-set setting, the characters "I>" will change and display "I>>" to indicate the High-set has been triggered.

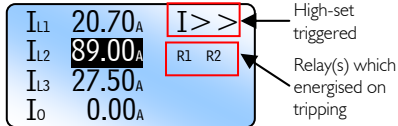

- When the unit finally trips, the digits of the phase at fault will stop flashing and remain highlighted. This allows the user to see which phase was at fault and caused the unit to trip.
- The red "Tripped" LED will also flash.
- The relays which energised are also displayed on the screen after tripping.
- Press  to reset and return the unit back to normal operation (assuming the fault has been cleared). The LCD reverts back to displaying the normal system currents and the red "Tripped" LED stops flashing.

☞ If either relay is set for Auto resetting, then they would have de-energised after the fault had cleared. The corresponding relay ident (i.e. R1 and/or R2) on the display would also disappear. Pressing the "RESET" button will only clear the LCD. If either relay is set for Manual resetting, then pressing the "RESET" button will de-energise the relay(s) and clear the LCD.

In the event of an Overcurrent condition, the basic sequence of events is shown below.

☞ Assuming High-set trip is enabled.

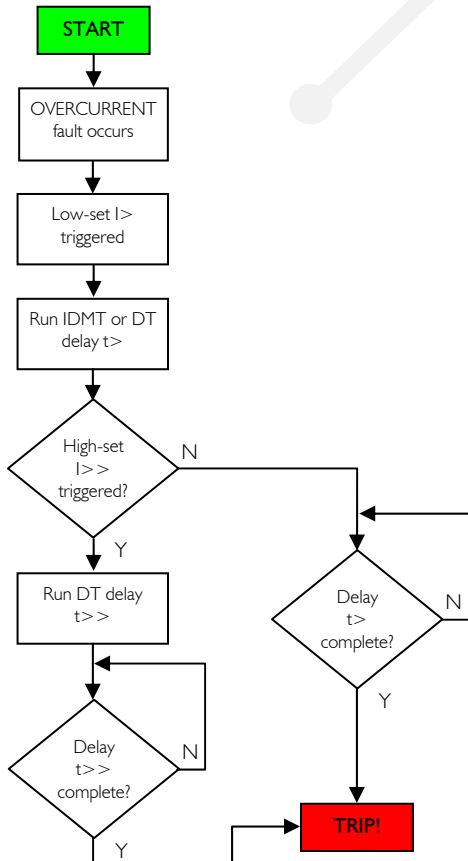

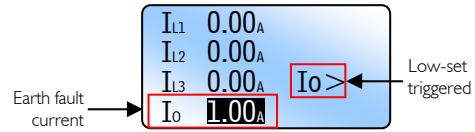

2. EARTH FAULT

- When an Earth fault occurs causing a flow in current through the Neutral, an increase in current reading on the LCD will occur. When the level of current exceeds the Low-set setting, the reading will be highlighted by the digits flashing.
- The LCD backlight will flash.
- Relay 2 will energise if assigned to Earth fault and set to energise at the start of the time out period (See Section 3. RELAY 2 SETTING).
- The characters "Io>" will display to indicate the Low-set has been triggered.

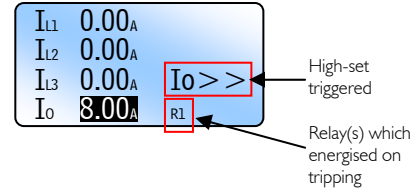

- If the current continues to increase above the High-set setting, the characters "Io>" will change and display "Io>>" to indicate the High-set has been triggered.



- When the unit finally trips, the digits will stop flashing and remain highlighted. This allows the user to see what caused the unit to trip.
- The red "Tripped" LED will also flash.
- The relays which energised are also displayed on the screen after tripping.
- Press  to reset and return the unit back to normal operation (assuming the fault has been cleared). The LCD reverts back to displaying the normal system currents and the red "Tripped" LED stops flashing.

☞ If either relay is set for Auto resetting, then they would have de-energised after the fault had cleared. The corresponding relay ident (i.e. R1 and/or R2) on the display would also disappear. Pressing the "RESET" button will only clear the LCD. If either relay is set for Manual resetting, then pressing the "RESET" button will de-energise the relay(s) and clear the LCD.

In the event of an Earth fault condition, the basic sequence of events is shown below.

☞ Assuming High-set trip is enabled.

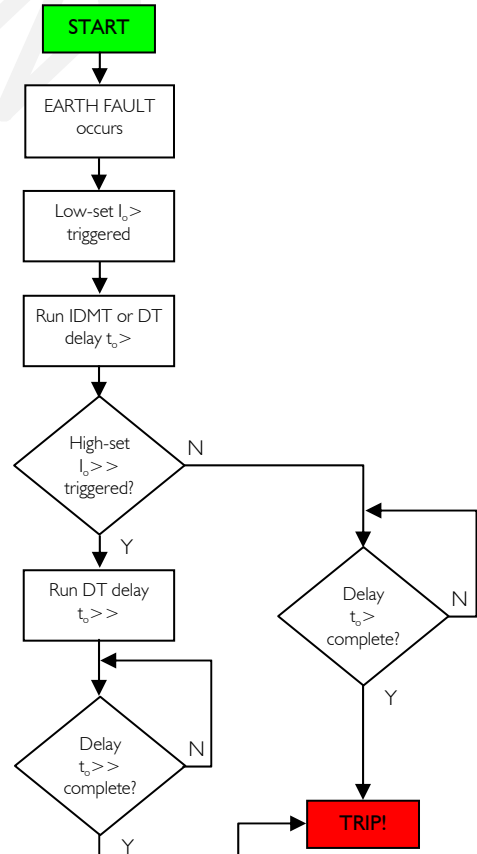

• ADDITIONAL MEASUREMENTS

With the 4-way connector wired and plugged in to the rear of the P9690, voltage and current present, it will be possible to measure and display the following information.

I. VOLTAGE MEASUREMENTS

PHASE TO NEUTRAL OR PHASE TO PHASE

☞ The frequency measurement "f" is derived from L1 and will therefore only appear on the LCD if L1 is present and the voltage is > 12V phase to neutral.

- Quickly press the  button and the following will appear on the LCD which provides the phase to neutral measurements of the phases connected. The system measured frequency is also displayed.

V _{L1/N}	230.0V
V _{L2/N}	230.0V
V _{L3/N}	230.0V
f	50.00Hz

Screen example showing the phase to neutral voltages and frequency

- Press the same button again to display the measured phase to phase voltages.

V _{L1}	400.0V
V _{L2}	400.0V
V _{L3}	400.0V
f	50.00Hz

Screen example showing the phase to phase voltages and frequency

2. POWER

☞ The actual power displayed will also be dependant on the selected Toroid ratio's. See examples on the right.

- After viewing the phase to phase voltages, pressing the same button again displays the calculated power for each phase.

P _{L1/N}	0.0W
P _{L2/N}	0.0W
P _{L3/N}	0.0W

3. POWER FACTOR

☞ By default, the displayed Power Factor will be 1.00.

- After viewing the calculated power, pressing the same button again displays the calculated power factor for each phase.

pf _{L1/N}	1.00
pf _{L2/N}	1.00
pf _{L3/N}	1.00

4. HOURS RUN

☞ This will run for as long as power is applied to the relay.

☞ The displayed time cannot be reset.

☞ The displayed time will be retained in memory during removal of power to the relay.

- After viewing the calculated power factor, pressing the same button again displays the hours run.

HOURS RUN	00000h 00m
-----------	------------

- Pressing the same button again will revert back to display the measured phase currents.

Notes

☞ If alterations to the User Settings are required whilst in one of the above screens, it will be necessary to exit first by pressing the  briefly.

5. FAULT CONDITION

- If any of the examples shown on the left appear on the LCD, it will be exited automatically should a fault occur which initiates an Overcurrent or Earth fault time out.
- The LCD will then revert to displaying which phase is at fault or whether the fault exists on the neutral. See "Tripping Modes" on the previous page.

6. EXAMPLES

The following examples show the expected measured information based on the voltage and currents present at the inputs. Trip settings are not taken in to account in the examples.

Example. 1

V_{L1/L2/L3} = 228V, I_{L1/L2/L3} = 6.35A, f = 50Hz, CT ratio = 5:5

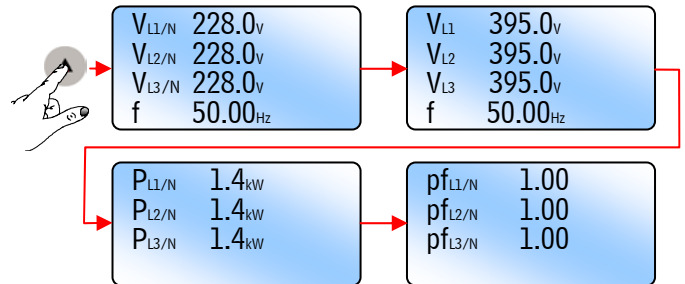

Example. 2

V_{L1/L2/L3} = 250V, I_{L1/L2/L3} = 1500A¹, f = 50Hz, CT ratio = 2000:5

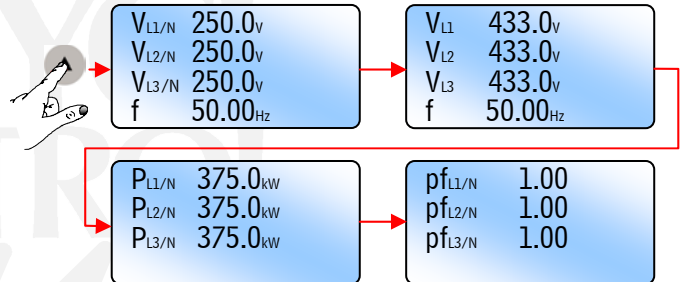

¹ Current on the primary side of the externally connected 2000A CT's

• **IDMT CHARACTERISTIC CURVES**

Normal Inverse 3/10 (NI 3/10)*

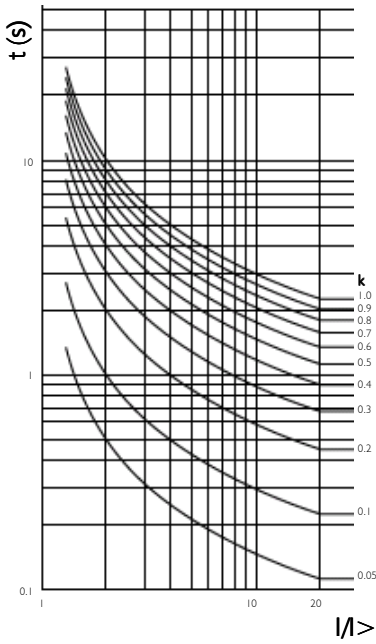

Normal Inverse 1.3/10 (NI 1.3/10)*

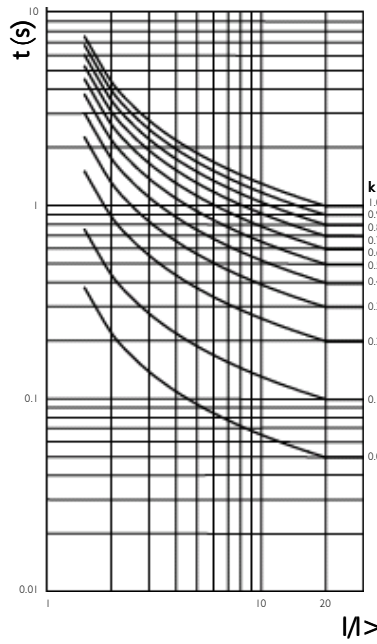

Long Time Inverse (LTI)*

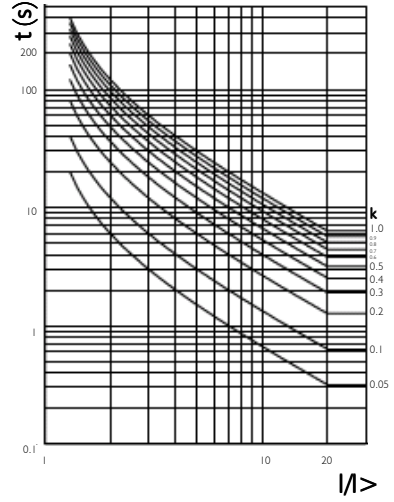

Very Inverse (VI)*

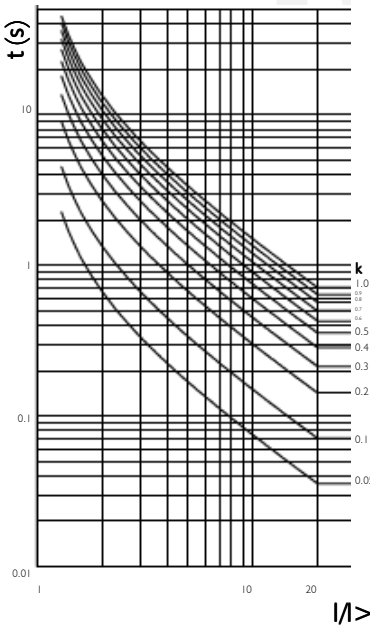

Extremely Inverse (EI)*

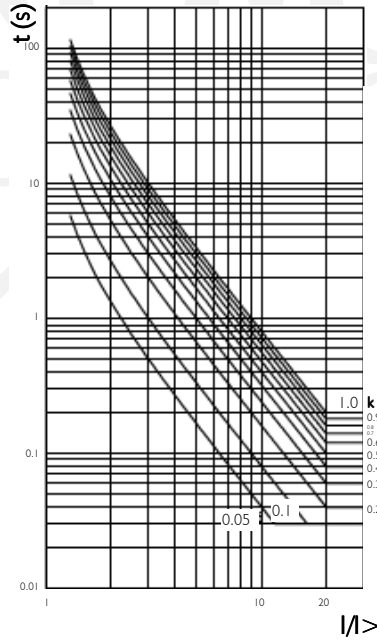

Extremely Inverse (EI 0.65)*

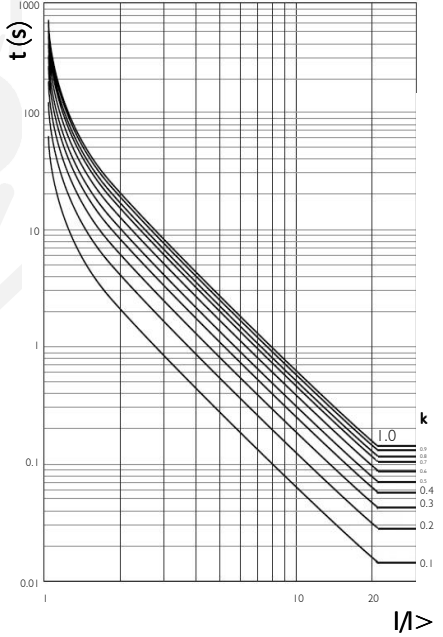

* Abbreviations used in the LCD screen for the selected IDMT characteristic curve.

The sequence of curves that are presented to the user when programming is shown below

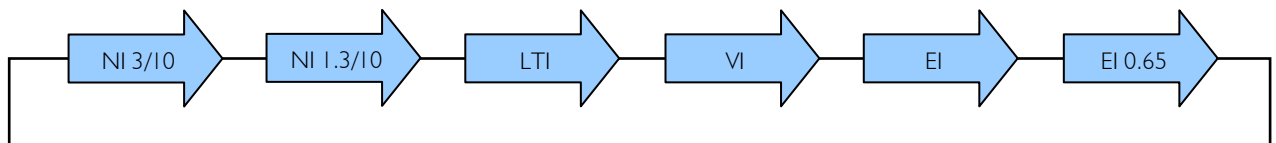

TECHNICAL SPECIFICATION



Supply voltage U_n (1, 2): 85 – 265VAC/85 – 370VDC
18 – 57VAC/18 – 75VDC

(Voltage range should be specified at time of ordering)

Rated frequency: 50/60Hz (AC Supplies)

Isolation: Over voltage cat. III

Rated impulse

withstand voltage: 4kV (1.2 / 50 μ s) IEC 60664

Power consumption: 3W max.

3-Phase voltage input

(L1, L2, L3, N): 3-Phase, 3 or 4-wire

Rated frequency: 50/60Hz

Measured voltage range: 12 – 400V phase to neutral

Rated impulse

withstand voltage: 4kV (1.2 / 50 μ s) IEC 60664

Rated current input I_n : 5A (directly connected)

Rated frequency: 50/60Hz

Burden: <0.4VA @ I_n

Overload: 4 x I_n (continuous)

External CT's (9.....16): Class P recommended. (with 5A secondary)

Maximum CT primary

current rating: 5000A

Overcurrent settings:

Low-set trip ($I_{>}$): 0.50 – 10.00A (10 – 200%)

Low-set time multiplier ($k_{>}$): 0.05 – 1.00

Low-set definite time ($t_{>}$): 0.05 – 100s

High-set trip ($I_{>>}$): 0.5 – 100A (10 – 2000%) or disable

High-set definite time ($t_{>>}$): 0.05 – 2.5s

Earth fault settings:

Low-set trip ($I_{o>}$): 0.10 – 5.00A (2 – 100%)

Low-set time multiplier ($k_{o>}$): 0.05 – 1.00

Low-set definite time ($t_{o>}$): 0.05 – 100s

High-set trip ($I_{o>>}$): 0.10 – 50.00A (2 – 1000%) or disable

High-set definite time ($t_{o>>}$): 0.05 – 2.5s

Pick up value: +2% of trip setting

Accuracy:

Protection thresholds: $\pm 5\%$

Time delay (DT): $\pm 5\%$ (with a minimum of 50mS)

Time delay (IDMT): $\pm 5\%$ (with a minimum of 50mS and $I > 1.2 \times$ set-trip)

Actual phase current: $\pm 1\%$ of rated current I_n

Actual Earth fault current: $\pm 1\%$ of rated current I_n

Voltage: 0.5% (> 100V AC)

Power: 2% of full scale (-90° to +90°)

Power factor: 2% (0.5 < pf < 1)

Frequency: $\pm 0.2\text{Hz}$ (45 to 65Hz)

Display update time: < 1 sec. (All measurements)

Repeat accuracy: $\pm 0.5\%$ @ constant conditions

Ambient temperature: -10 to +60°C

Relative humidity: +95%

CONNECTION DIAGRAM

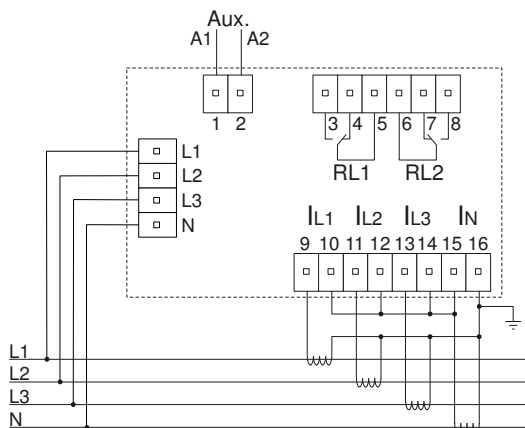

Output:

(RL1 - 3, 4, 5):

1 x SPDT relay

(RL2 - 6, 7, 8):

1 x SPDT relay

Output rating:

AC1 250V 8A (2000VA)

AC15 250V 5A (1250VA)

DC1 25V 8A (200W)

Electrical life:

$\geq 150,000$ ops at rated load

Dielectric voltage:

2kV AC (rms) IEC 60947-1

Rated impulse

withstand voltage:

4kV (1.2 / 50 μ s) IEC 60664

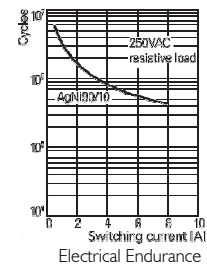
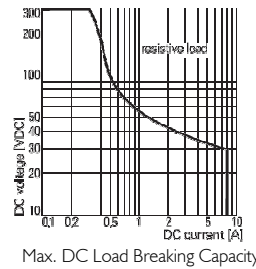

Housing:

Flame retardant Lexan

Protection:

IP55 / IP20 (rear)

Weight:

$\approx 640\text{g}$

Mounting:

Panel mounting. Cut-out = 91 x 91mm ($\pm 0.5\text{mm}$)

Max. panel thickness:

12mm

Terminal type:

UL94 V-0 rated pluggable and re-wireable female connectors comprising:

2-way (Power supply 1, 2)

6-way (Relay contacts 3...8)

8-way (Phase current and neutral inputs 9...16)

4-way (3-Phase Voltage Input L1...N)

Terminal conductor size:

0.05 - 2.5mm² (30 - 12AWG)

Recommended tightening

torque:

4.4in lb (0.5Nm)

Wire stripping length:

0.24 – 0.30in (6 – 7.5mm)

Approvals:

Conforms to IEC, CE and and RoHS Compliant.

EMC: Immunity: EN/IEC 61000-6-2

Emissions: EN/IEC 61000-6-4

Generic: IEC 60255-26 (EMC), IEC 255-3, IEC 60255-151

() Bold digits in brackets refer to terminal numbers on the rear of the unit.

Options:

The P9600 range also includes individual Overcurrent or Earth fault relays available with either IDMT or DT characteristics. Please refer to separate data sheets.

DIMENSIONS

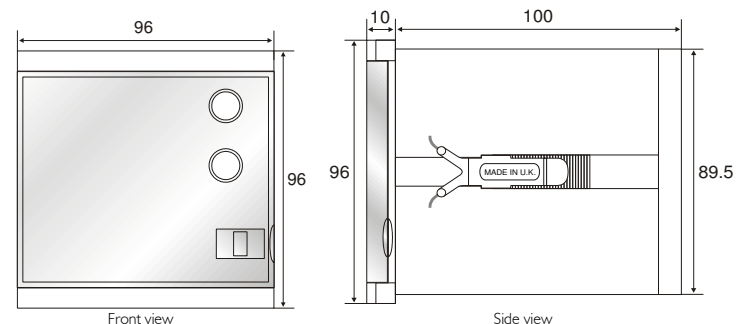

All dimensions are in mm.



Broyce Control Ltd., Pool Street, Wolverhampton, West Midlands WV2 4HN. England

Tel: +44 (0) 1902 773746 Fax: +44 (0) 1902 420639 Email: sales@broycecontrol.com Web: www.broycecontrol.com

The information provided in this literature is believed to be accurate (subject to change without prior notice); however, use of such information shall be entirely at the user's own risk.

P9690-1-A 7
012375